

KLT-T5K-OV7675 V1.0 NIR

0.3MP OmniVision OV7675 Parallele DVP-Schnittstelle
Kein IR-Filter Fester Fokus Kameramodul

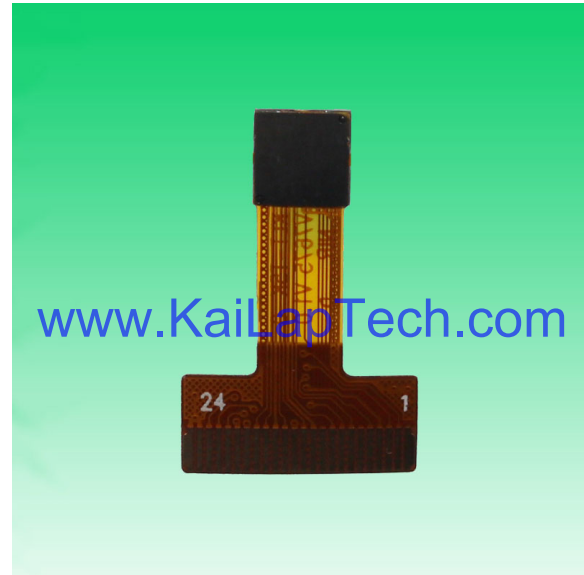

Vorderansicht



Rückansicht

Spezifikationen

Kameramodul Nr.	KLT-T5K-OV7675 V1.0 NIR
Auflösung	0.3MP
Bildsensor	OV7675
Sensorart	1/9"
Pixel Größe	2.5 um x 2.5 um
EFL	1.90 mm
F.NO	2.80
Pixel	640 x 480
Betrachtungswinkel	57.0°(DFOV)
Linsenabmessungen	5.00 x 5.00 x 2.85 mm
Modulgröße	19.50 x 12.50 mm
Modultyp	Fester Fokus
Schnittstelle	DVP-Parallel
Autofokus-VCM-Treiber-IC	Keiner
Linsenmodell	KLT-LENS-TR01A-H550A
Linsentyp	Keine IR-Filterlinse
Betriebstemperatur	-30°C to +70°C
Gegenstecker	FH12-24S-0.5SH

**KLT-T5K-OV7675 V1.0 NIR**

**0.3MP OmniVision OV7675 Parallele DVP-Schnittstelle
Kein IR-Filter Fester Fokus Kameramodul**



Ansicht von oben

www.KaiLapTech.com

Seitenansicht

www.KaiLapTech.com

Untersicht

www.KaiLapTech.com

Gegenstecker

www.KaiLapTech.com

CONNECTOR
24PIN DESCRIPTION

PIN	SIGNAL
1	NC
2	AGND
3	SID_D
4	AVDD 2.8V
5	SID_C
6	NC
7	VSYNC
8	PWIND
9	HREF
10	NC
11	DDVDD
12	D7
13	XCLK
14	D6
15	DGND
16	D5
17	PCLK
18	D4
19	D0
20	D3
21	D1
22	D2
23	DGND
24	DGND

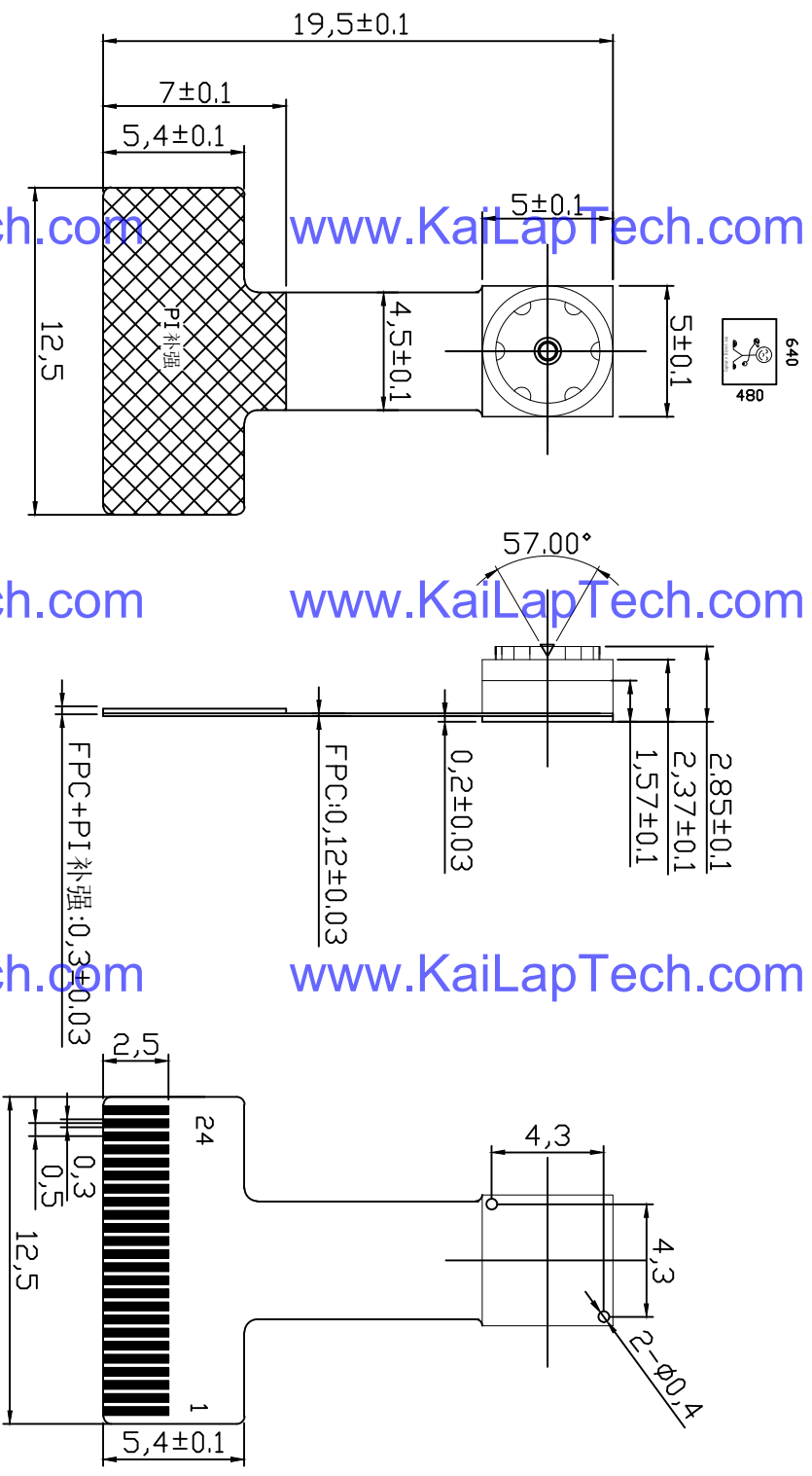

SELECT	Level	A	B	C	D
100~	±0,10%	±0,15%	±0,20%	±0,30%	
50~100	±0,10	±0,15	±0,20	±0,25	
10~50	±0,08	±0,10	±0,15	±0,20	
5~10	±0,05	±0,08	±0,10	±0,15	
~5	±0,03	±0,05	±0,08	±0,10	

Parameter	Value
EFL	1,9mm
F/NO	2,8
View Angle	57°
Distortion	<1,0%
Depth Of Field	pixel
Lens T ype	1/9inch
Image Sensor	DV7675

1/0	All	First Release	Kevin	7/5/2019
REV.	Zone	Description	Approved	Date
Kai Lap Technologies Group Ltd				
Designed By:		Client Name: 7675		
Checked By:		Model Name: KLT-TSK-DV7675 V1.0 NIR		
Approved By:		Projection Type: Third Angle		
Aouly_Yan		Unit: mm		
		Material: -----		
		Scale: 1:1		
		Sheet: 1 of 1		
		Version: 1/0		

ROHS



Lens Model: KLT-LENS-TR01A-H550A

SPECIFICATION:

- FOR 1/9" SENSOR
- MAX IMAGE CIRCLE : $\phi 2.3mm$
- SENSOR IMAGE CIRCLE: $\phi 2.0mm$
- FFL=1.80mm
- BFL (OPTICAL)=0.97mm
(INCLUDING 0.21mm IR AND 0.40mm COVER GLASS)
- BFL (MECHANICAL)=-0.61mm
(INCLUDING 0.40mm COVER GLASS)
- F/NO=2.8 \pm 5%
- FOV=57°
- TV DISTORTION<1%
- RELATIVE ILLUMINATION>50%
- CONSTRUCTION: 2P+IR GLASS
(IR-CUT COATING 650 \pm 10nm)
- THREAD M4 \times 0.3P

IMAGE PLANE

IR FILTER
COVER GLASS
IMAGE PLANE

NO.	更改内容	NAME	DATE	X X	±0.1	一般公差	UNIT	MATERIAL	SCALE	SURFACE	FINISH	PINTISH	NAME	DATE
4	尺寸变更	高宁威	2015-7-16			尺寸范围						A4	高宁威	2010-6-6
3	图框变更	高宁威	2013-7-27			ANGLE								
2	新规发行	高宁威	2010-6-6											
1														

0.5mm and 1mm Pitch Connectors For FPC/FFC

FH12 Series

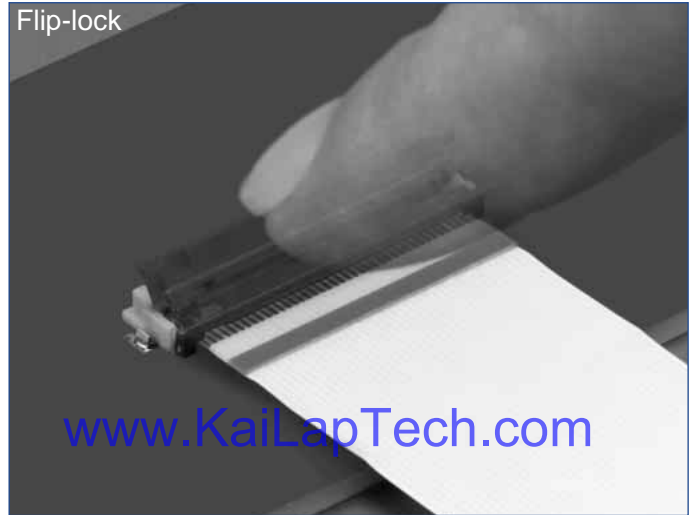
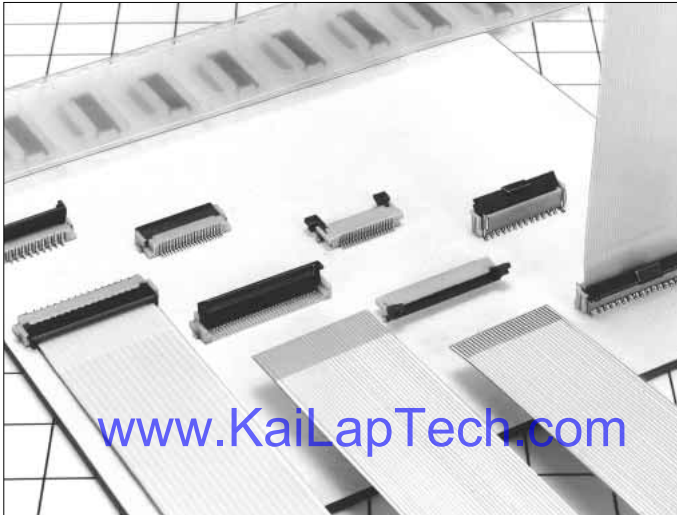

■ Features

1. Ease of Use and Space Savings

Only one finger or 6.9N (Newtons) of force is required to lock Hirose's rotational actuator (flip-lock) as compared to using 2 fingers and 39.2N to close a FFC/FPC connector from our competition.

The Flip-Lock design also allows customers to place 2 or more connectors side by side as there is no need to waste additional board space for a side latch.

2. Strengthened Flip-lock Actuator

The standard Flip-Lock requires only 2.0mm height above the board. A strengthened lock lever is available which only requires an additional 0.4mm.

3. Supports Thin FPC (0.18mm)

Hirose does not require double-sided FPC to have any additional strengthening plate or stiffener and can therefore support a thickness of as little as 0.18mm +/- 0.05.

4. Hirose Ensures Reliability

Hirose's patented half tuning fork contacts maintain the required normal force without relying on the connector housing. With our competitor's conventional products the housing walls support the contact force, which does not provide for long-term reliability.

5. Prevention of Solder Bridge

Excess solder cavity absorbs excessive solder and avoids solder bridging.

6. Three different assembly types

FH12 is offered in Top & Bottom Contact and Vertical Mount and offered in both a 0.5mm contact pitch as well as a 1.0mm contact pitch (bottom contact only).

■ Applications

Notebook computers, printers, PDAs, digital cameras and other compact devices for interconnecting the main circuit board with the LCD, HDD or other device.

Rotating One-touch Mechanism

①

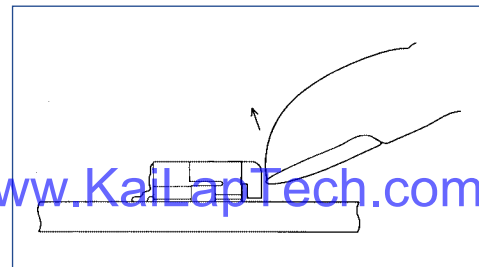

②

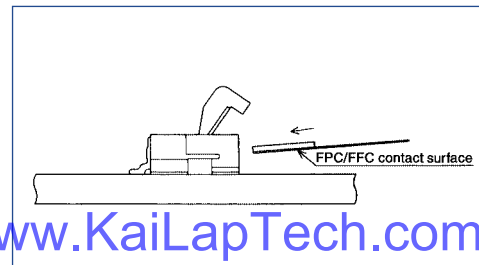

③

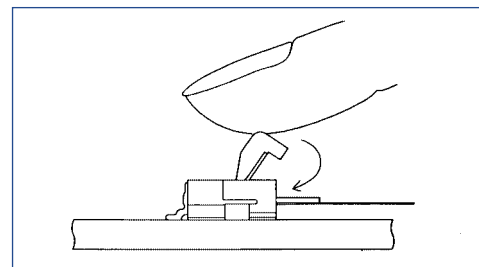

Product Specifications

Rating	Current rating: 0.5A DC(Note 1)	Operating Temperature Range: -40 to +70°C (Note 2)	Storage Temperature Range: -10 to +50°C (Note 3)
	Voltage rating: 50V AC	Operating Humidity Range: Relative humidity, 90% max. (Not dewed)	Storage Humidity Range: Relative humidity, 90% max. (Not dewed)

Applicable FPC	t=0.3±0.05 Gold plated	t=0.18 ± 0.05 for FH12F-*S-0.5SH
----------------	------------------------	----------------------------------

Item	Specification	Conditions
1. Insulation resistance	500M ohms minimum	100V DC
2. Withstanding voltage	No flashover or insulation breakdown.	150V AC/1 minute
3. Contact resistance	50m ohms maximum	1mA
4. Durability (Insertion/withdrawal)	Contact resistance: 50m ohms maximum No damage, cracks, or parts dislocation.	20 cycles
5. Vibration	No electrical discontinuity of 1μs or more Contact resistance: 50m ohms maximum. No damage, cracks, or parts dislocation.	Frequency: 10 to 55 Hz, single amplitude of 0.75 mm, 2 hours in each of the 3 directions.
6. Shock	No electrical discontinuity of 1μs or more Contact resistance: 50m ohms maximum. No damage, cracks, or parts dislocation.	Acceleration of 490 m/s ² , 11 ms duration, sine half-wave waveform, 3 cycles in each of the 3 axis.
7. Humidity(Steady state)	Contact resistance: 50m ohms maximum. Insulation resistance: 50M ohms minimum. No damage, cracks, or parts dislocation.	96 hours at 40°C and humidity of 90% to 95%
8. Temperature Cycle	Contact resistance: 50m ohms maximum. Insulation resistance: 50M ohms minimum. No damage, cracks, or parts dislocation.	Temperature: -40°C → 15 to 35°C → 85°C → 15 to 35°C, Time: 30 → 5 max. → 30 → 5 max.(minutes) 5 cycles
9. Resistance to Soldering heat	No deformation of components affecting performance.	Reflow: At the recommended temperature profile Manual soldering: 350±5°C for 3 seconds

Note 1: When passing the current through all of the contacts, use 70% of the current rating.

Note 2: Includes temperature rise caused by current flow.

Note 3: The term "storage" refers to products stored for long period of time prior to mounting and use. Operating Temperature Range and Humidity range covers nonconducting condition of installed connectors in storage, shipment or during transportation.

Material

Part	Material	Finish	Remarks
Insulator	Polyamide, LCP(60 pos.)	Color : Beige	UL94V-0
Actuator	PPS	Color : Dark brown	
Contact	Phosphor bronze	Gold plated	
Metal Fittings	Brass	Tin plated	

Ordering Information

FH12 **A** - **10** (**4**) - **S** **A** - **0.5** **SH** (**55**)
 ① ② ③ ④ ⑤ ⑥ ⑦ ⑧ ⑨

① Series Name : FH12	⑤ Contact alignment: Single
② Blank : standard type A : Top contact type S : Type with strengthened flip-lock actuator F : Type with 0.18mm FPC End Thickness	⑥ Eccentric direction: Blank : standard type A : Eccentric type
③ Standard type : Number of contacts Eccentric type : Number of contacts in 0.5mm housing	⑦ Contacts Pitch : 0.5mm, 1mm
④ Standard type : Blank Eccentric type : Number of contacts	⑧ Contact type SH : SMT horizontal mounting type SV : SMT vertical mounting type
	⑨ Plating specification (55) : Gold plated

FH12 Series 0.5mm and 1mm Pitch Connectors For FPC/FPC

Series Configuration

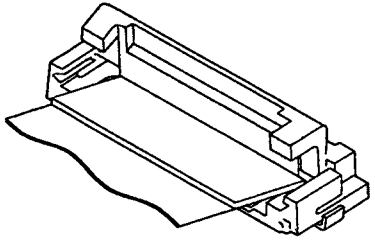
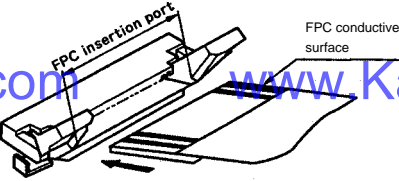
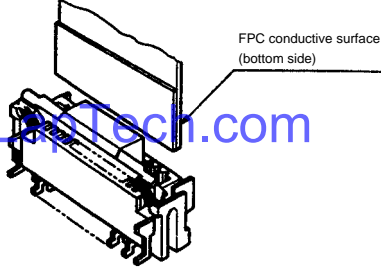
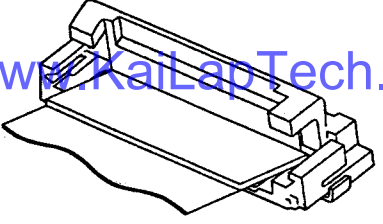
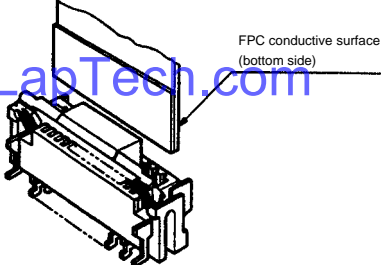
Pitch	Bottom Contact Type	Top Contact Type	Vertical mounting Type
0.5mm	 <p>FH12-**-S-0.5SH P.12</p> <p>Number of contacts 6, 8, 10, 11, 12, 13, 14, 15, 16, 17, 18, 19, 20, 22, 24, 25, 26, 28, 30, 32, 33, 34, 35, 36, 40, 45, 50, 53</p>	 <p>FPC insertion port FPC conductive surface</p>	 <p>FPC conductive surface (bottom side)</p>
	<p>Type with Strengthened Lock Lever</p>		
	<p>FH12S-**-S-0.5SH P.13</p> <p>Number of contacts 30, 40, 45, 50, 53</p> <p>Type with 0.18mm FPC End Thickness</p>		
	<p>FH12F-**-S-0.5SH P.14</p> <p>Number of contacts 6, 8, 10, 12, 13, 14, 15, 16, 18, 20, 22, 24, 25, 26, 28, 30, 32, 34, 36, 40</p>		
1mm	 <p>FH12-**-S-1SH P.18</p> <p>Standard Eccentric FH12-**-S-1SA P.18</p> <p>Standard Number of contacts 5, 6, 7, 8, 9, 11, 12, 16, 17, 22, 26</p> <p>Eccentric Number of contacts 4, 6, 8, 10, 11, 14, 19, 24</p>		 <p>FPC conductive surface (bottom side)</p> <p>FH12-**-S-1SV P.19</p> <p>Number of contacts 6, 7, 8, 16, 20, 22, 24</p>

0.5mm Pitch Bottom Contact Type

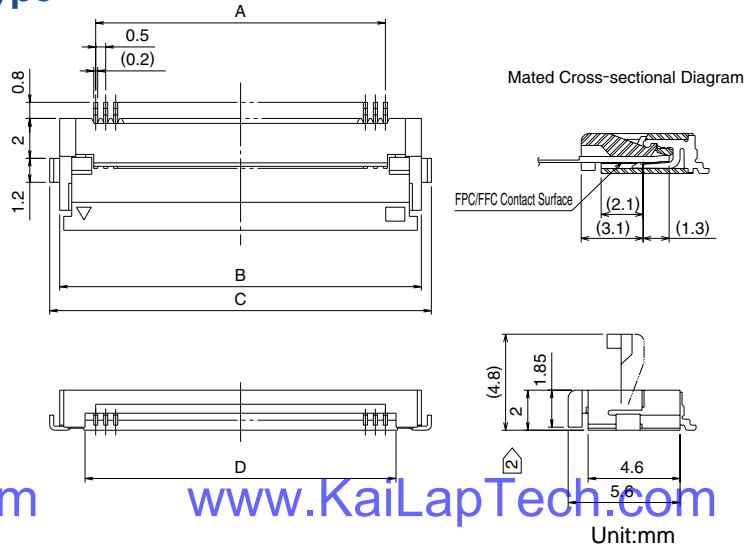

www.KaiLapTech.com

www.KaiLapTech.com

Part Number	CL No.	Number of Contacts	A	B	C	D	RoHS
FH12- 6S-0.5SH(55)	586-0582-5-55	6	2.5	6.1	7.1	3.57	YES
FH12- 8S-0.5SH(55)	586-0744-5-55	8	3.5	7.1	8.1	4.57	
FH12-10S-0.5SH(55)	586-0522-3-55	10	4.5	8.1	9.1	5.57	
FH12-11S-0.5SH(55)	586-0600-5-55	11	5	8.6	9.6	6.07	
FH12-12S-0.5SH(55)	586-0704-0-55	12	5.5	9.1	10.1	6.57	
FH12-13S-0.5SH(55)	586-0549-0-55	13	6	9.6	10.6	7.07	
FH12-14S-0.5SH(55)	586-0533-0-55	14	6.5	10.1	11.1	7.57	
FH12-15S-0.5SH(55)	586-0523-6-55	15	7	10.6	11.6	8.07	
FH12-16S-0.5SH(55)	586-0531-4-55	16	7.5	11.1	12.1	8.57	
FH12-17S-0.5SH(55)	586-0606-1-55	17	8	11.6	12.6	9.07	
FH12-18S-0.5SH(55)	586-0530-1-55	18	8.5	12.1	13.1	9.57	
FH12-19S-0.5SH(55)	586-0534-2-55	19	9	12.6	13.6	10.07	
FH12-20S-0.5SH(55)	586-0524-9-55	20	9.5	13.1	14.1	10.57	
FH12-22S-0.5SH(55)	586-0532-7-55	22	10.5	14.1	15.1	11.57	
FH12-24S-0.5SH(55)	586-0521-0-55	24	11.5	15.1	16.1	12.57	
FH12-25S-0.5SH(55)	586-0692-3-55	25	12	15.6	16.6	13.07	
FH12-26S-0.5SH(55)	586-0576-2-55	26	12.5	16.1	17.1	13.57	
FH12-28S-0.5SH(55)	586-0612-4-55	28	13.5	17.1	18.1	14.57	
Note ② FH12-30S-0.5SH(55)	586-0525-1-55	30	14.5	18.1	19.1	15.57	
FH12-32S-0.5SH(55)	586-0681-7-55	32	15.5	19.1	20.1	16.57	
FH12-33S-0.5SH(55)	586-0520-8-55	33	16	19.6	20.6	17.07	
FH12-34S-0.5SH(55)	586-0617-8-55	34	16.5	20.1	21.1	17.57	
FH12-35S-0.5SH(55)	586-0740-4-55	35	17.0	20.6	21.6	18.07	
FH12-36S-0.5SH(55)	586-0526-4-55	36	17.5	21.1	22.1	18.57	
Note ② FH12-40S-0.5SH(55)	586-0527-7-55	40	19.5	23.1	24.1	20.57	
Note ② FH12-45S-0.5SH(55)	586-0528-0-55	45	22	25.6	26.6	23.07	
Note ② FH12-50S-0.5SH(55)	586-0529-2-55	50	24.5	28.1	29.1	25.57	
Note ② FH12-53S-0.5SH(55)	586-0595-7-55	53	26	29.6	30.6	27.07	

Note 1 : Embossed tape reel packaging (2,000 pieces/reel).
 Order by number of reels.

Note ② : If there is no problem with the connector height, we recommend the type with the strengthened Flip-lock actuator (FH12S-*S-0.5SH).
 Standard type connector height: 2 mm
 Connector height of type with strengthened Flip-lock actuator: 2.4 mm

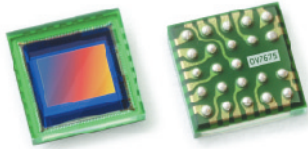

OV7675 VGA product brief



Higher Performance, Feature Rich VGA Sensor to Support Fast Growing Emerging Markets



available in a lead-free package

The OV7675 is a high performance VGA sensor designed specifically to address growing demand for consumer electronics from emerging markets. Its small optical format enables ultra-thin camera modules, which, combined with its excellent low-light performance, make it a very attractive solution for entry-level and mainstream mobile phones, notebooks, netbooks and webcams.

The OV7675 is a low-voltage color CMOS image sensor that supports the full functionality of a single chip VGA (640 x 480) camera in a small footprint package. The 1/9-inch OV7675 uses a unique 2.5-micron OmniPixel3-HS™ pixel design, which allows it to offer best-in-class low-light sensitivity (1800 mV/lux-sec), significantly reduced noise and outstanding color reproduction.

The OV7675 provides full-frame, sub-sampled, windowed images in VGA, QVGA and QQVGA formats via the control of the serial camera control bus (SCCB) interface. Its image array is capable of operating at up to 30 frames per second (fps) in full VGA resolution with complete user control over image quality, formatting and output data transfer.

All required image processing functions, including exposure control, gamma, white balance, color saturation, hue control, defective pixel canceling, noise canceling are programmable through the SCCB interface. In addition, OmniVision image sensors use proprietary sensor technology to improve image quality by reducing or eliminating common lighting/electrical sources of image contamination, such as fixed pattern noise and smearing to produce a clean, fully stable color image.

Find out more at www.ovt.com.

Applications

- Mobile Phones
- Notebooks/Netbooks and Webcams

Product Features

- support for image sizes: VGA (640 x 480), QVGA (320 x 240) and QQVGA (160 x 120)
- support for output formats: YUV4:2:2, RAW RGB, ITU656, RGB565
- digital video port (DVP) parallel output interface
- on-chip phase lock loop (PLL)
- built-in 1.5V regulator for core
- capable of maintaining register values at power down
- programmable controls for frame rate, mirror and flip, AEC/AGC, and windowing
- support for horizontal and vertical sub-sampling
- automatic image control functions:
 - automatic exposure control (AEC)
 - automatic white balance (AWB)
 - automatic black level calibration (ABLC)
- image quality controls: defect pixel correction and lens shading correction
- support for black sun cancellation
- standard serial SCCB interface
- parallel I/O tri-state configurability and programmable polarity
- module size: 6 mm x 6 mm

www.KaiLapTech.com

www.KaiLapTech.com

OV7675

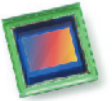

Ordering Information

- **OV07675-A23A**
(color, lead-free, 23-pin CSP3)
- **OV07675-G04A**
(color, chip probing, 200 µm backgrinding, reconstructed wafer)
- **OV07175-A23A**
(B&W, lead-free, 23-pin CSP3)

Product Specifications

- **active array size:** 640 x 480
- **power supply:**
 - analog: 2.6 - 3.0 V
 - core: 1.5 V +5% (internal regulator)
 - I/O: 1.7 - 3.0 V
- **power requirements:**
 - active: 98 mW
 - standby: 60 µW
- **temperature range:**
 - operating: -30°C to 70°C junction temperature
 - stable image: 0°C to 50°C junction temperature
- **output formats:** YUV422, RAW RGB, ITU656, RGB565
- **lens size:** 1/9"
- **lens chief ray angle:** 21°
- **input clock frequency:** 1.5 - 27 MHz
- **scan mode:** progressive
- **maximum image transfer rate:**
 - VGA: 30 fps
 - QVGA: 60 fps
 - QQVGA: 240 fps
- **sensitivity:** 1.800 mV/µm²sec
- **shutter:** rolling shutter
- **max S/N ratio:** 38 dB
- **dynamic range:** 71 dB @ 8x gain
- **maximum exposure interval:** 510 x t_{row}
- **pixel size:** 2.5 µm x 2.5 µm
- **dark current:** 10 mV/s @ 60°C junction temperature
- **image area:** 1640 µm x 1220 µm
- **package dimensions:**
 - CSP3: 2815 µm x 2825 µm
 - COB: 2830 µm x 2840 µm

www.KaiLapTech.com

www.KaiLapTech.com

Functional Block Diagram

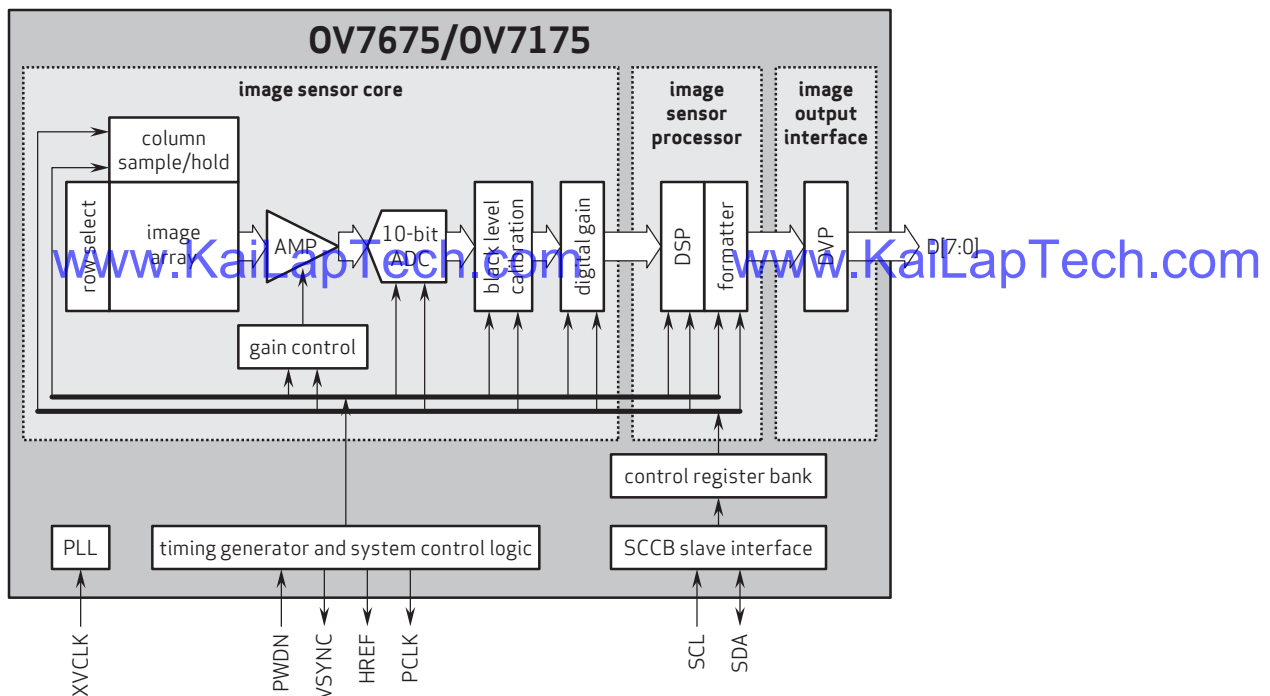

4275 Burton Drive
Santa Clara, CA 95054
USA

Tel: +1 408 567 3000
Fax: +1 408 567 3001
www.ovt.com

OmniVision reserves the right to make changes to their products or to discontinue any product or service without further notice. OmniVision, the OmniVision logo and OmniPixel are registered trademarks of OmniVision Technologies, Inc. OmniPixel3-H5 is a trademark of OmniVision Technologies, Inc. All other trademarks are the property of their respective owners.





Referenztable für die Pinbelegungsdefinition des Kameramoduls

OmniVision Sony Himax Samsung On-Semi Aptina Himax GalaxyCore PixArt Bildsensoren	
Pin Signal	Beschreibung
DGND GND	Masse für digitale Schaltung
AGND	Masse für analoge Schaltung
PCLK DCK	DVP-PCLK-Ausgang
XCLR PWDN XSHUTDOWN STANDBY	Abschalten aktiv hoch mit internem Pulldown-Widerstand
MCLK XVCLK XCLK INCK	Systemeingangsuhr
RESET RST	Aktiv Low mit internem Pull-up-Widerstand zurücksetzen
NC NULL	keine Verbindung
SDA SIO_D SIOD	SCCB-Daten
SCL SIO_C SOIC	SCCB-Eingangstakt
VSYNC XVS FSYNC	DVP-VSYNC-Ausgang
HREF XHS	DVP-HREF-Ausgang
DOVDD	Strom für E/A-Schaltung
AFVDD	Strom für VCM-Schaltung
AVDD	Strom für analoge Schaltung
DVDD	Strom für digitale Schaltung
STROBE FSTROBE	Strobe-Ausgang
FSIN	Synchronisieren Sie das VSYNC-Signal vom anderen Sensor
SID	SCCB letzte Bit-ID-Eingabe
ILPWM	mechanische Shutter-Ausgangsanzeige
FREX	Rahmenbelichtung / mechanischer Verschluss
GPIO	Allzweckeingänge
SLASEL	I2C-Slave-Adresse auswählen
AFEN	CEN-Chip aktivieren aktiv hoch auf VCM-Treiber-IC
MIPI Schnittstelle	
MDN0 DN0 MD0N DATA_N DMO1N	MIPI 1st negative Ausgabe der Datenspur
MDP0 DP0 MD0P DATA_P DMO1P	MIPI 1st positiver Ausgang der Datenspur
MDN1 DN1 MD1N DATA2_N DMO2N	MIPI 2nd negative Ausgabe der Datenspur
MDP1 DP1 MD1P DATA2_P DMO2P	MIPI 2nd positiver Ausgang der Datenspur
MDN2 DN2 MD2N DATA3_N DMO3N	MIPI 3rd negative Ausgabe der Datenspur
MDP2 DP2 MD2P DATA3_P DMO3P	MIPI 3rd positiver Ausgang der Datenspur
MDN3 DN3 MD3N DATA4_N DMO4N	MIPI 4th negative Ausgabe der Datenspur
MDP3 DP3 MD3P DATA4_P DMO4P	MIPI 4th positiver Ausgang der Datenspur
MCN CLKN CLK_N DCKN	MIPI Uhr negativer Ausgang
MCP CLKP MCP_CLK_P DCKN	MIPI Takt positiver Ausgang
DVP Parallel Schnittstelle	
D0 DO0 Y0	DVP Datenausgabeport 0
D1 DO1 Y1	DVP Datenausgabeport 1
D2 DO2 Y2	DVP Datenausgabeport 2
D3 DO3 Y3	DVP Datenausgabeport 3
D4 DO4 Y4	DVP Datenausgabeport 4
D5 DO5 Y5	DVP Datenausgabeport 5
D6 DO6 Y6	DVP Datenausgabeport 6
D7 DO7 Y7	DVP Datenausgabeport 7
D8 DO8 Y8	DVP Datenausgabeport 8
D9 DO9 Y9	DVP Datenausgabeport 9
D10 DO10 Y10	DVP Datenausgabeport 10
D11 DO11 Y11	DVP Datenausgabeport 11



your **BEST** camera module partner

Kameraanwendungen



www.KaiLapTech.com

www.KaiLapTech.com



IMAGING DEVICES



www.KaiLapTech.com

www.KaiLapTech.com



www.KaiLapTech.com

www.KaiLapTech.com



Kamera-Zuverlässigkeitstest

Reliability Inspection Item		Testmethode	Akzeptanzkriterium	
Kategorie	Artikel			
Umwelt	Lager Temperatur	Hoch 60°C 96 Std	Temperaturkammer	Keine anormale Situation
		Niedrig -20°C 96 Std	Temperaturkammer	Keine anormale Situation
	Betriebs Temperatur	Hoch 60°C 24 Std	Temperaturkammer	Keine anormale Situation
		Niedrig -20°C 24 Std	Temperaturkammer	Keine anormale Situation
	Feuchtigkeit	60°C 80% 24 Std	Temperaturkammer	Keine anormale Situation
	Thermischer Schock	Hoch 60°C 0.5 Std Niedrig -20°C 0.5 Std Radfahren rein 24 Std	Temperaturkammer	Keine anormale Situation
Physisch	Falltest (Im freien Fall)	Ohne Verpackung 60cm	10 Mal auf Holzboden	Elektrisch funktionsfähig
		Mit Paket 60cm	10 Mal auf Holzboden	Elektrisch funktionsfähig
	Vibrations Test	50Hz X-Axis 2mm 30 Minuten	Vibrationstisch	Elektrisch funktionsfähig
		50Hz Y-Axis 2mm 30 Minuten	Vibrationstisch	Elektrisch funktionsfähig
		50Hz Z-Axis 2mm 30 Minuten	Vibrationstisch	Elektrisch funktionsfähig
	Zugfestigkeit des Kabels Krafttest	Gewicht laden 4 kg 60 Sekunden Radfahren rein 24 Std	Zugprüfmaschine	Elektrisch funktionsfähig
Elektrisch	ESD-Test	Kontaktaufnahme 2 KV	ESD-Prüfmaschine	Elektrisch funktionsfähig
		Luftentladung 4 KV	ESD-Prüfmaschine	Elektrisch funktionsfähig
	Alterungstest	On/Off 30 Sekunden Radfahren rein 24 Std	Stromschalter	Elektrisch funktionsfähig
	USB-Anschluss	On/Off 250 Mal	Einstecken und ausstecken	Elektrisch funktionsfähig





Inspektionsgegenstand		Untersuchungsmethode	Inspektionsstandard	
Kategorie	Artikel			
Aussehen	FPC oder PCB	Farbe	Das bloße Auge	Größere Unterschiede sind nicht zulässig.
		Zerrissen/gehackt werden	Das bloße Auge	Das Freilegen von Kupferrissen ist nicht zulässig.
		Markierung	Das bloße Auge	Klar, erkennbar (innerhalb von 30 cm Entfernung)
	Halterin	Kratzer	Das bloße Auge	Die Freilegung von Rissen im Inneren ist nicht zulässig
		Lücke	Das bloße Auge	Erfüllen Sie den Höhenstandard
		Schraube	Das bloße Auge	Stellen Sie sicher, dass Schrauben vorhanden sind (falls vorhanden)
		Schaden	Das bloße Auge	Die Freilegung von Rissen im Inneren ist nicht zulässig
	Linse	Kratzen	Das bloße Auge	Keine Auswirkung auf den Auflösungsstandard
		Kontamination	Das bloße Auge	Keine Auswirkung auf den Auflösungsstandard
		Ölfilm	Das bloße Auge	Keine Auswirkung auf den Auflösungsstandard
Abdeckband		Das bloße Auge	Kein Problem beim Aussehen.	
Funktion	Bild	Keine Kommunikation	Testboard	Nicht erlaubt
		Helles Pixel	Tafel	Im Image Center nicht erlaubt
		Dunkles Pixel	Weißer Tafel	Im Image Center nicht erlaubt
		Verschwommen	Das bloße Auge	Nicht erlaubt
		Kein Bild	Das bloße Auge	Nicht erlaubt
		Vertikale Linie	Das bloße Auge	Nicht erlaubt
		Horizontale Linie	Das bloße Auge	Nicht erlaubt
		Kleines Leck	Das bloße Auge	Nicht erlaubt
		Blinkendes Bild	Das bloße Auge	Nicht erlaubt
		Prellung	Inspektionslehre	Nicht erlaubt
		Auflösung	Diagramm	Folgt dem Diagrammstandard für ausgehende Inspektionen
		Farbe	Das bloße Auge	Kein Problem
		Lärm	Das bloße Auge	Nicht erlaubt
		Ecke dunkel	Das bloße Auge	Weniger als 100 x 100 Pixel
Farbauflösung	Das bloße Auge	Kein Problem		
Abmessungen	Höhe	Das bloße Auge	Befolgt Zulassungsdatenblatt	
	Breite	Das bloße Auge	Befolgt Zulassungsdatenblatt	
	Länge	Das bloße Auge	Befolgt Zulassungsdatenblatt	
	Gesamt	Das bloße Auge	Befolgt Zulassungsdatenblatt	



KLT-Paketlösungen

KLT Kameramodul



Komplett mit Linsenschutzfolie



Tablett mit Gitter und Raum



Legen Sie die Kameras auf das Tablett



Paketlösung für Kameramodule

Volles Tablett mit Cameras

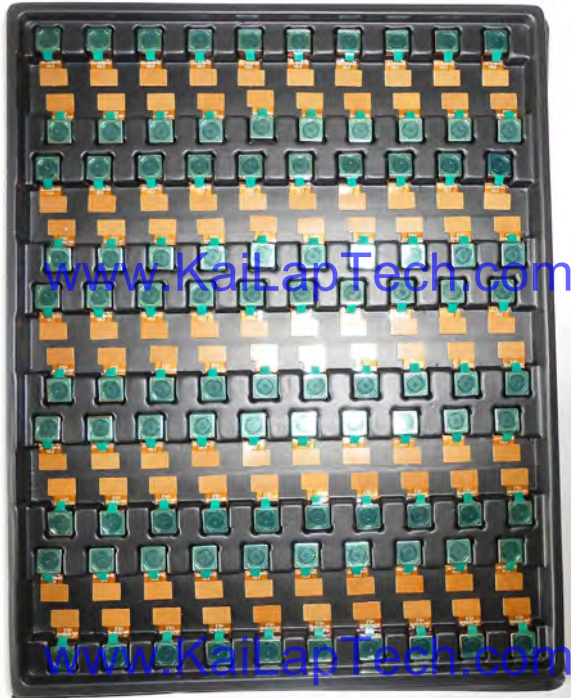

Abdeckschale mit Deckel



In Antistatikbeutel stecken



Staubsaugen Sie den antistatischen Beutel

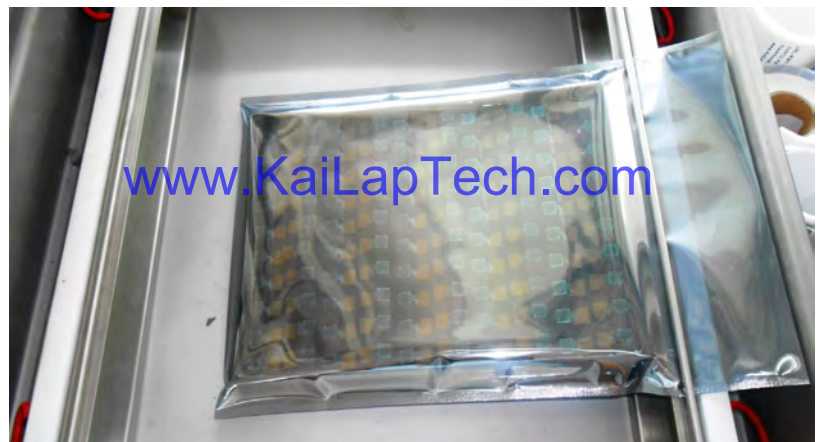



Paketlösung für Kameramodule

Versiegelter Vakuumbbeutel mit Etiketten

1. Modell und Beschreibung 2. Menge 3. Versanddatum 4. Achtung





Paketlösung für große Bestellungen

Schaumstoffplatten zwischen
die Tablettts legen



Schaumstoffplatten sind etwas
größer als Tablettts



www.KaiLapTech.com

Legen Sie Schaumstoffplatten und
Tablettts in die Schachtel



www.KaiLapTech.com

Schaumstoffplatten sind eng anliegende Box





Paketlösung für kleine Bestellungen

Legen Sie die Schaumstoffplatten und
Tablets in die kleine Schachtel



www.KaiLapTech.com

Paket in kleiner Box für den Versand

Schaumstoffplatten passen gut in
die kleine Box



www.KaiLapTech.com

Legen Sie kleine Kartons in größere Kartons





your **BEST** camera module partner

Carbon Box Paketlösung

Verschließen Sie die Carbonbox

Beschriftete Schachtel mit Endverpackung



- Versandfertige Karbonbox**
1. Lieferadresse und Telefonnummer
 2. Box-Nr. und Versanddatum
 3. Zerbrechliche Vorsicht



Lösung für Musterbestellungspakete

Legen Sie die Probe in einen kleinen antistatischen Beutel



Stecken Sie die Anschlüsse in den kleinen antistatischen Beutel



Musteretiketten auf dem kleinen Beutel

1. Kameramodul oder Anschlussmodell 2. Lieferdatum und Menge 3. Achtung



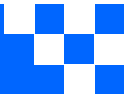

Steckverbinder Paketlösung für große Bestellungen

Steckverbinder in einem Rad



Steckverbinder im Rad beschriftet



Das Rad passt perfekt in die Box



Steckerbox versandfertig



Unternehmen Kai Lap Technologies (KLT)

Kai Lap Technologies Group Limited. (KLT) wurde 2009 gegründet und ist ein technologiegetriebener Hersteller der nächsten Generation, der sich auf Forschung, Design und Produktion von Audio- und Videoprodukten spezialisiert hat. KLT verfügt über 20.000 Quadratfuß automatisierte Fabriken mit 100 Mitarbeitern und einem jährlichen Durchsatz von 30.000.000 Kameraeinheiten.

KLT bietet OEM-, ODM-Design, Auftragsfertigung und baut die Kameraprodukte. Sie können uns die Anforderungen auch mit einem Handentwurf übermitteln, unser Vertrieb und unsere Technik arbeiten zusammen, um Ihre Anforderungen zu erfüllen. Wir verstehen uns als Ihr langfristiger Partner bei der Entwicklung praktischer und innovativer Lösungen.

Unser Team deckt alles von der ersten Konzeptentwicklung bis zum Massenprodukt ab. KLT ist spezialisiert auf kundenspezifisches Kameradesign, Rohmaterial, Elektrotechnik, Firmware-/Softwareentwicklung, Produkttests und Verpackungsdesign. Unsere erfahrenen strategischen Versorgungssysteme bieten eine robuste und zuverlässige Fertigungskapazität für Aufträge unterschiedlicher Größe.

www.KaiLapTech.comwww.KaiLapTech.com**Eingeschränkte Garantie**

KLT gewährt die folgende eingeschränkte Garantie, wenn Sie das/die Produkt(e) direkt von der Firma KLT oder von der Website von KLT, www.KaiLapTech.com, gekauft haben. Produkte, die von anderen Verkäufern oder Quellen gekauft wurden, fallen nicht unter diese beschränkte Garantie. KLT garantiert, dass das/die Produkt(e) bei normalem Gebrauch für einen Zeitraum von einem (1) Jahr ab dem Datum, an dem Sie das Produkt erhalten („Garanzzeitraum“), frei von Material- und Verarbeitungsfehlern sind.

Für alle Produkte, die während des Garanzzeitraums Material- oder Verarbeitungsfehler enthalten oder entwickeln, wird KLT nach eigenem Ermessen entweder: (i) die Produkte reparieren; (ii) das/die Produkt(e) durch ein neues oder generalüberholtes Produkt(e) ersetzen (Ersatzprodukt(e) sind von identischem Modell oder funktionell gleichwertig); oder (iii) Ihnen den Preis erstatten, den Sie für das/die Produkt(e) gezahlt haben.

Diese eingeschränkte Garantie von KLT ist ausschließlich auf Reparatur und/oder Ersatz zu den oben genannten Bedingungen beschränkt. KLT ist nicht zuverlässig oder verantwortlich für nachfolgende Ereignisse.





CMOS CAMERA MODULES



your BEST camera module partner

KLT Stärke

Leistungsstarke Fabrik



www.KaiLapTech.com

www.KaiLapTech.com

Professioneller Service



www.KaiLapTech.com

www.KaiLapTech.com

Versprochene Lieferung



www.KaiLapTech.com

www.KaiLapTech.com



www.KaiLapTech.com sales@KaiLapTech.com Tel: (852) 6908 1256 Fax: (852) 3017 6778

All rights reserved @ Kai Lap Technologies Group Ltd. Specifications subject to change without notice.